

Drive Shaft

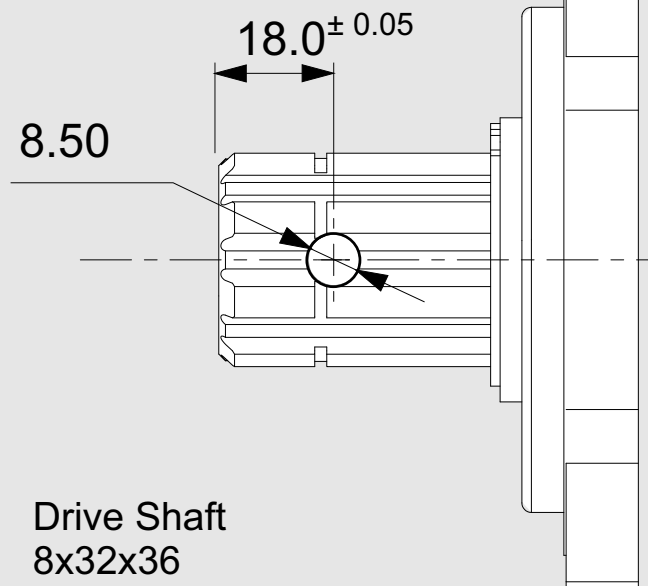

Coupling Flange

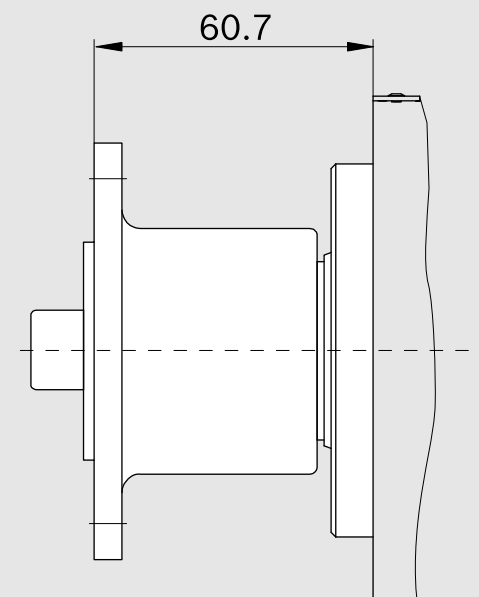

<b>x 1000 rpm</b>	18,00 cc
<b>x 1500 rpm</b>	27,00 cc
<b>Max. Continuous Pump Speed</b>	2300 rpm
<b>Max. Limited Pump Speed</b>	2900 rpm
<b>Max. Continuous Pressure</b>	350 bar
<b>Max. Intermit. Peak Pressure</b>	400 bar
<b>Max. Torque at 350 bar</b>	105 Nm
<b>Weight without inlet fitting</b>	9,00 kg
<b>Weight with inlet fitting</b>	9,40 kg
<b>Torque without inlet fitting</b>	8,75 N.m
<b>Torque with inlet fitting</b>	9,19 N.m
<b>Rotation</b>	CW-CCW
<b>Fluid</b>	Min.B.Hyd.Oil
<b>Inlet &amp; Outlet</b>	3/4"

