

Splined Shaft : 8x32x36 DIN ISO 14 NF

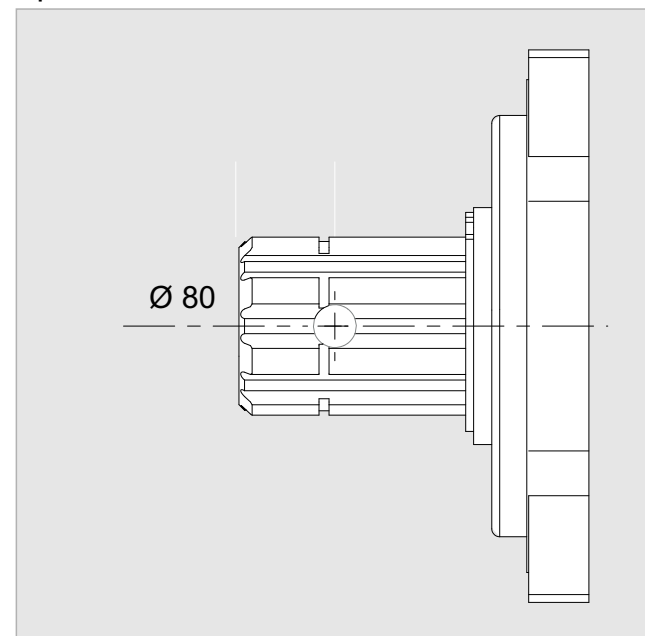

Parallel Keyed Shaft: DIN 6885 8x7x40

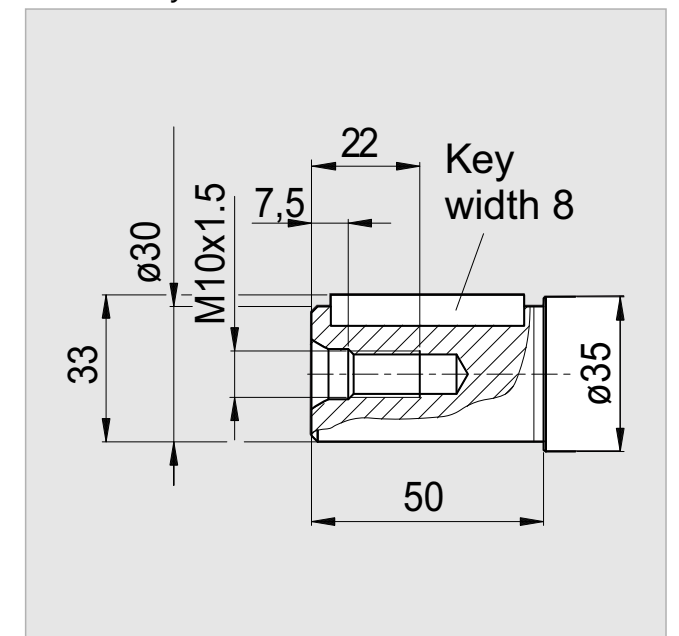

x 1000 rpm	18,00 cc
x 1500 rpm	27,00 cc
Max. Continuous Pump Speed	8000 rpm
Max. Intermittent Pump Speed	8800 rpm
Max. Continuous Pressure	400 bar
Max. Peak Pressure	450 bar
Torque bar	0.28 m.N/bar
Torque at 350 bar	98 m.N
Weight without accessories	10,00 kg
Weight with accessories	10,50 kg
Max. Motor Temperature	-25°
Min. Motor Temperature	110°