

Splined Shaft : 8x32x36 DIN ISO 14 NF

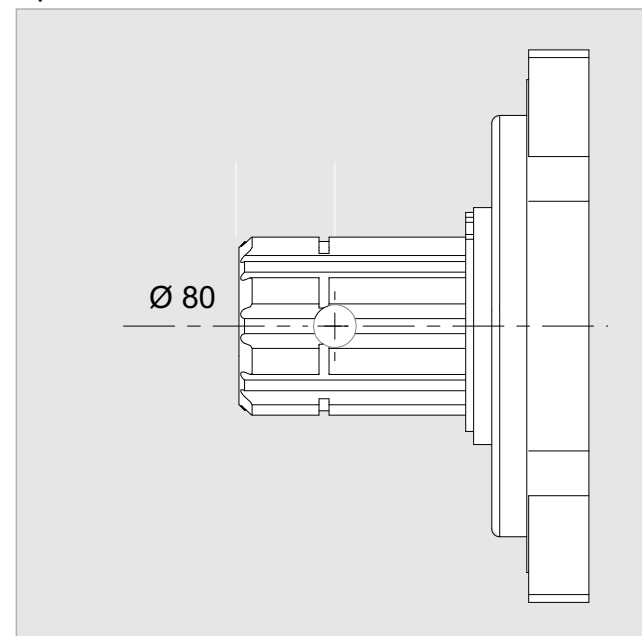

Parallel Keyed Shaft: DIN 6885 8x7x50

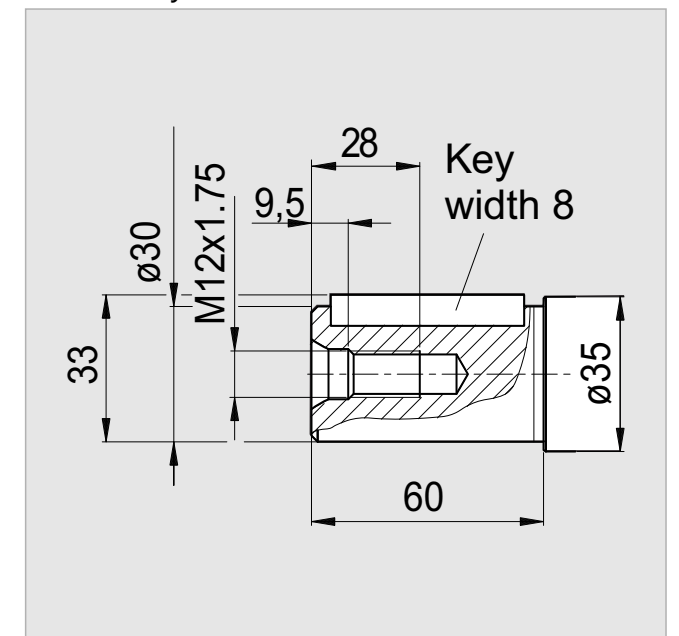

<b>x 1000 rpm</b>	32,00 cc
<b>x 1500 rpm</b>	48,00 cc
<b>Max. Continuous Pump Speed</b>	6250 rpm
<b>Max. Intermittent Pump Speed</b>	6800 rpm
<b>Max. Continuous Pressure</b>	400 bar
<b>Max. Peak Pressure</b>	450 bar
<b>Torque bar</b>	0.51 m.N/bar
<b>Torque at 350 bar</b>	174 m.N
<b>Weight without accessories</b>	11,00 kg
<b>Weight with accessories</b>	11,50 kg
<b>Max. Motor Temperature</b>	-25°
<b>Min. Motor Temperature</b>	110°