

Splined Shaft : 8x32x36 DIN ISO 14 NF

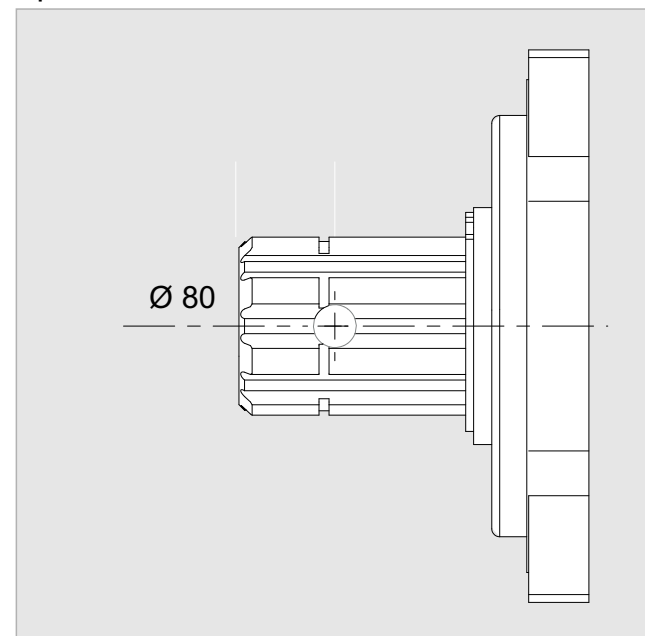

Parallel Keyed Shaft: DIN 6885 8x7x50

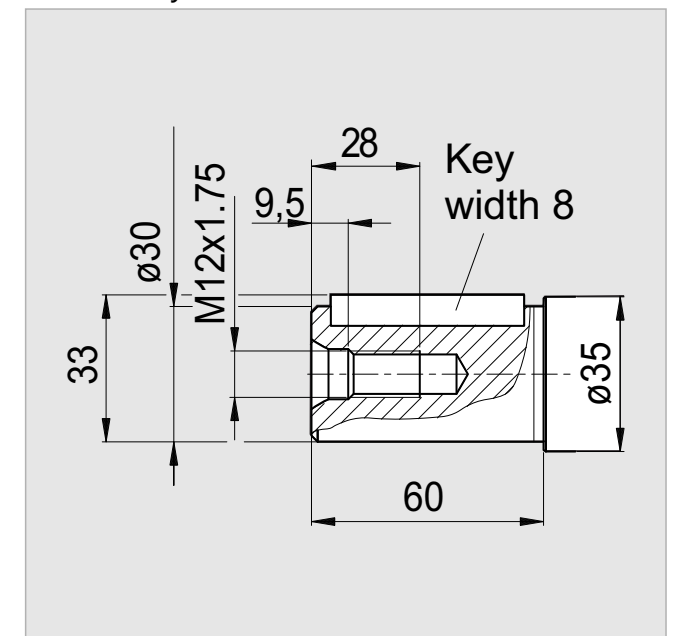

x 1000 rpm	40,20 cc
x 1500 rpm	60,30 cc
Max. Continuous Pump Speed	5600 rpm
Max. Intermittent Pump Speed	6300 rpm
Max. Continuous Pressure	400 bar
Max. Peak Pressure	450 bar
Torque bar	0.65 m.N/bar
Torque at 350 bar	228 m.N
Weight without accessories	11,00 kg
Weight with accessories	11,50 kg
Max. Motor Temperature	-25°
Min. Motor Temperature	110°