

Splined Shaft : 8x32x36 DIN ISO 14 NF

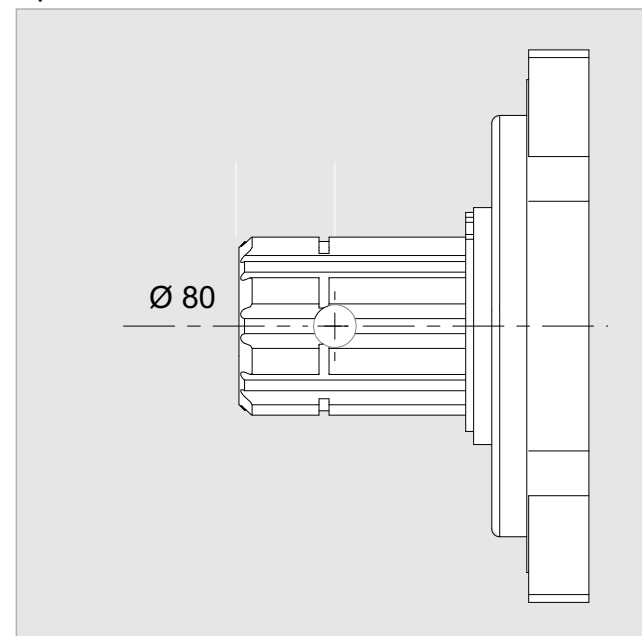

Parallel Keyed Shaft: DIN 6885 10x8x50

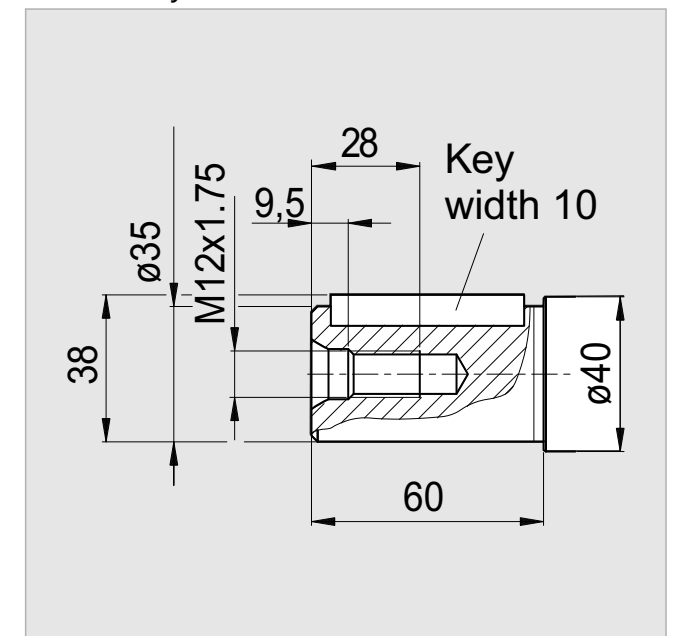

<b>x 1000 rpm</b>	56,40 cc
<b>x 1500 rpm</b>	84,60 cc
<b>Max. Continuous Pump Speed</b>	5000 rpm
<b>Max. Intermittent Pump Speed</b>	5500 rpm
<b>Max. Continuous Pressure</b>	400 bar
<b>Max. Peak Pressure</b>	450 bar
<b>Torque bar</b>	0.92 m.N/bar
<b>Torque at 350 bar</b>	320 m.N
<b>Weight without accessories</b>	12,00 kg
<b>Weight with accessories</b>	12,50 kg
<b>Max. Motor Temperature</b>	-25°
<b>Min. Motor Temperature</b>	110°