

Splined Shaft : 8x32x36 DIN ISO 14 NF

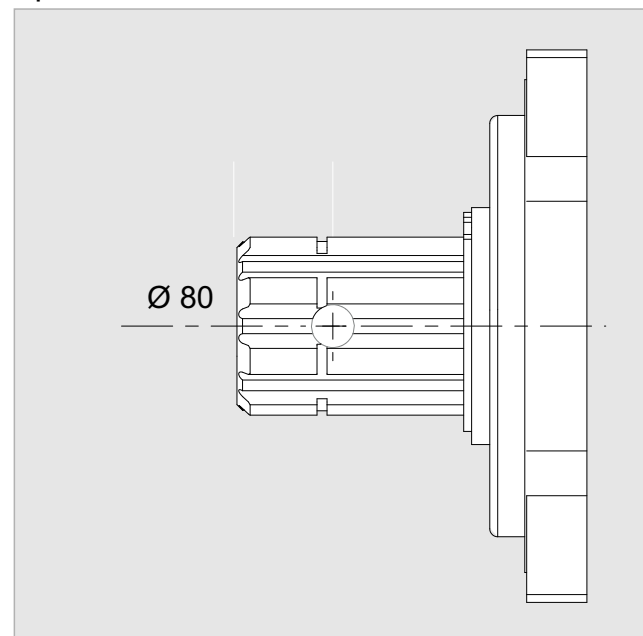

Parallel Keyed Shaft: DIN 6885 10x8x56

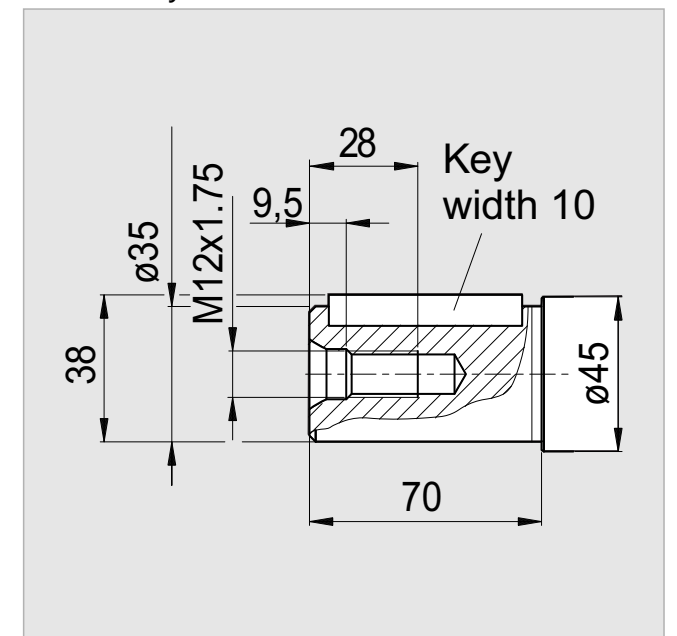

x 1000 rpm	80,00 cc
x 1500 rpm	120,00 cc
Max. Continuous Pump Speed	4400 rpm
Max. Intermittent Pump Speed	4900 rpm
Max. Continuous Pressure	400 bar
Max. Peak Pressure	450 bar
Torque bar	1.28 m.N/bar
Torque at 350 bar	440 m.N
Weight without accessories	15,00 kg
Weight with accessories	15,50 kg
Max. Motor Temperature	-25°
Min. Motor Temperature	110°