

SAE D 13T-8/16
SAE C 14T-12/24

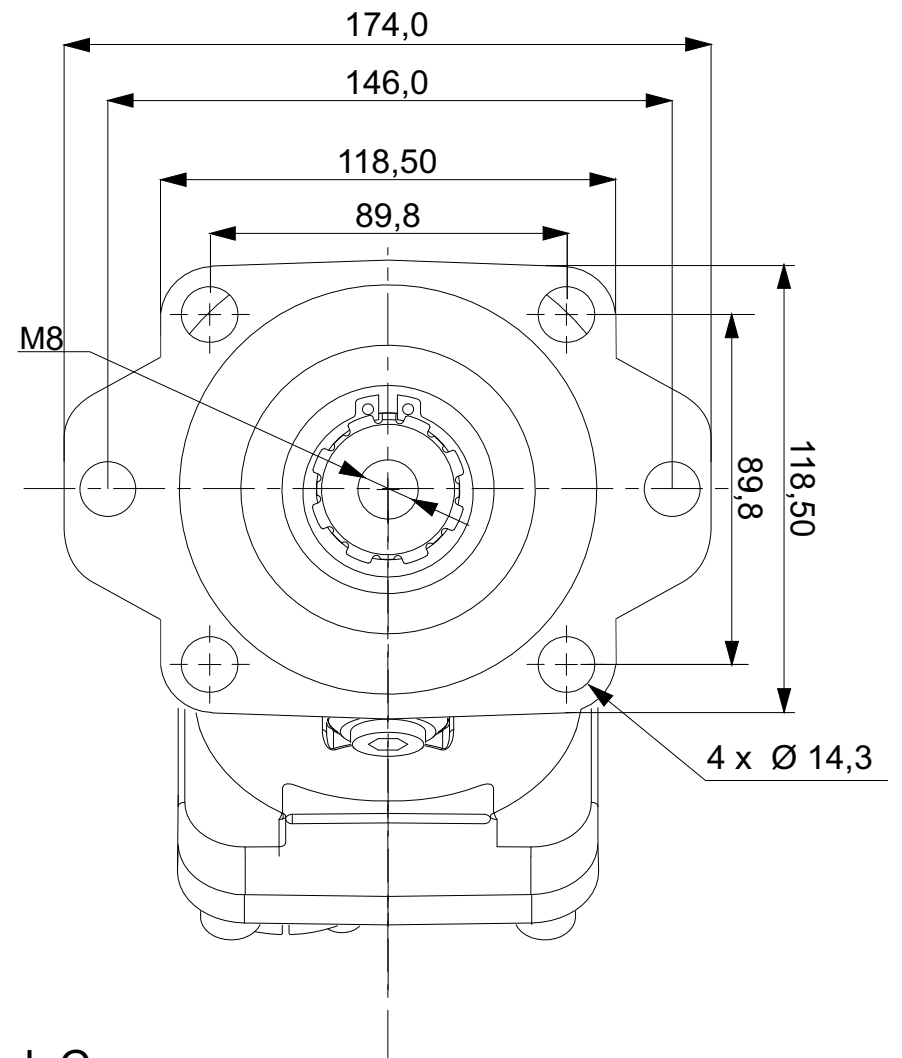

Spline Shaft

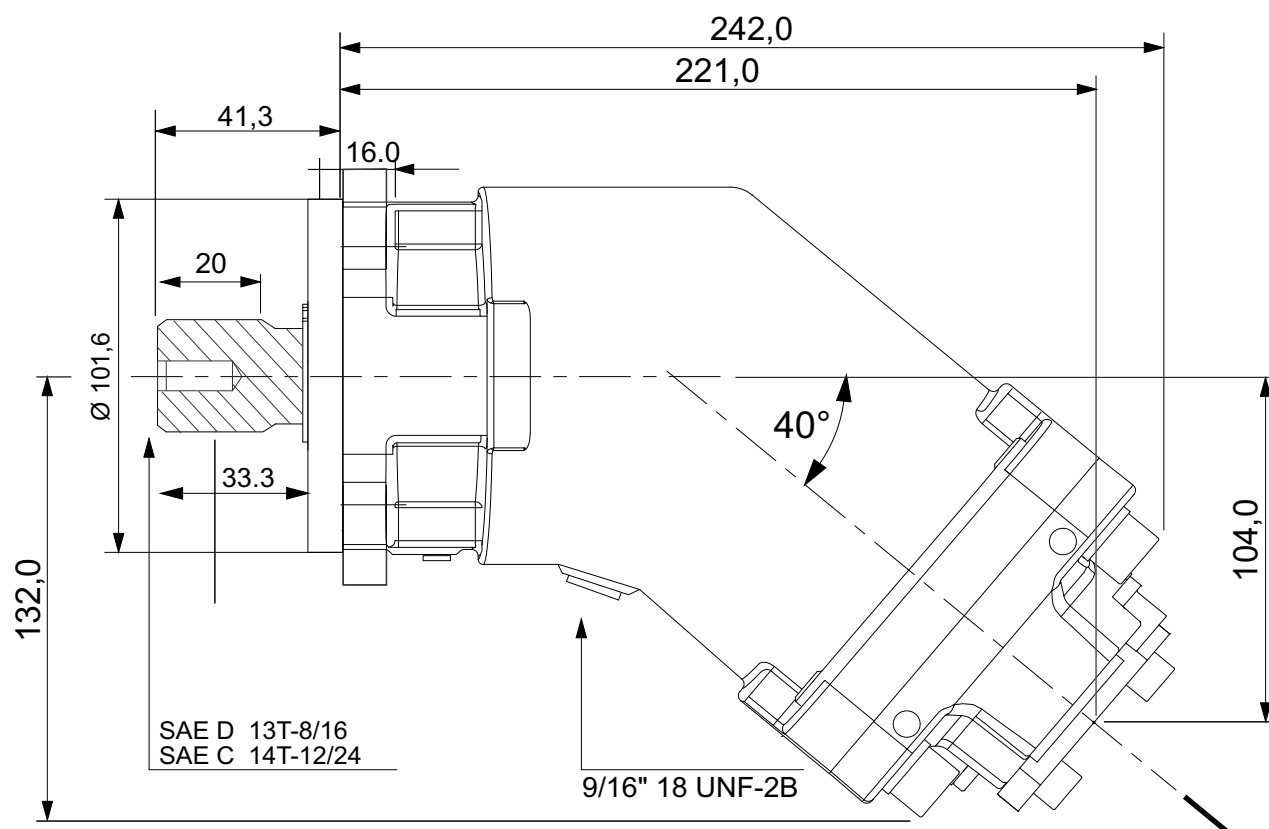
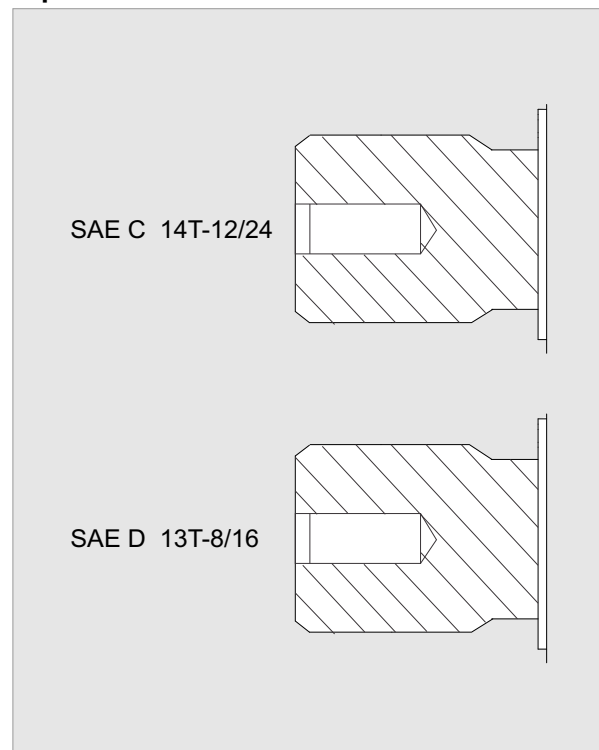

Keyed Shaft

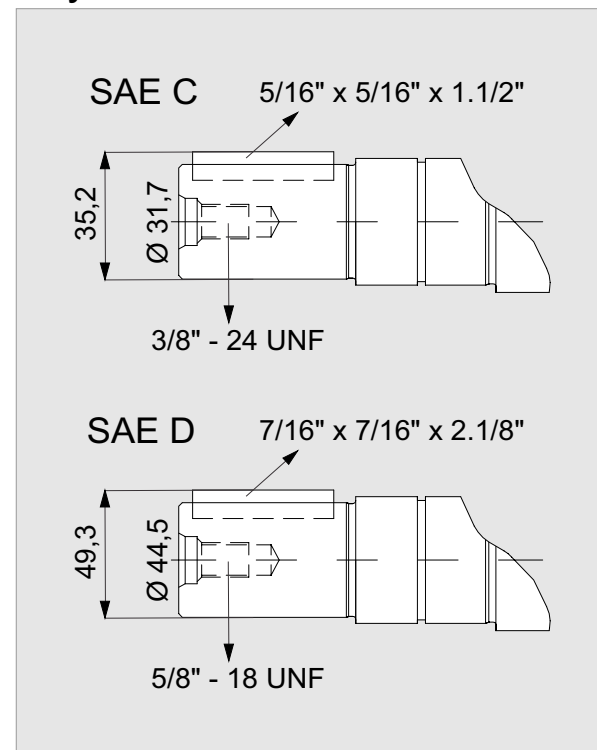

Back Cover

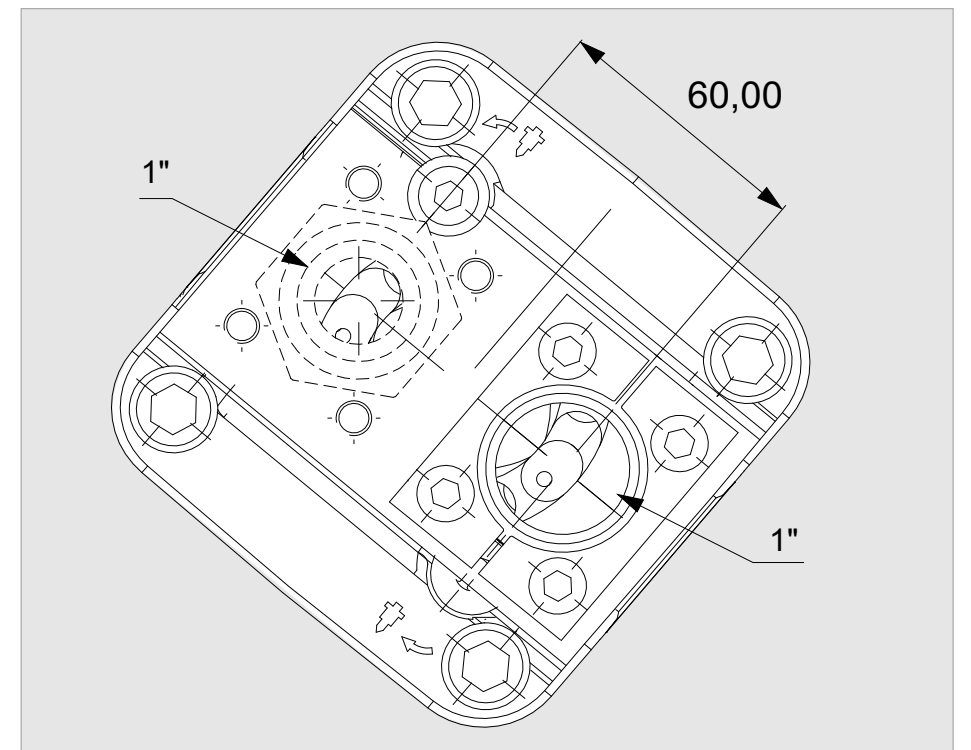

x 1000 rpm	80,00 cc
x 1500 rpm	120,00 cc
Max. Continuous Pump Speed	1700 rpm
Max. Limited Pump Speed	2100 rpm
Max. Continuous Pressure	350 bar
Max. Intermit. Peak Pressure	400 bar
Max. Torque at 350 bar	460 Nm
Weight without inlet fitting	16,00 kg
Weight with inlet fitting	16,40 kg
Rotation	CW-CCW

